



**INSTRUCTIONS D'ASSEMBLAGE**  
**ASSEMBLY INSTRUCTIONS**

---

**M**ONARCH  
SPECIALTIES INC.

# I 2750

---

**ETAGERE -**  
**72" H / GRIS-NOIR EN COIN**

**BOOKCASE -**  
**72" H / GREY-BLACK CORNER ACCENT ETAGERE**







**POUR DE L'ASSISTANCE OU POUR COMMANDER  
DES PIÈCES CONTACTEZ NOTRE DÉPARTEMENT  
DE SERVICE À LA CLIENTÈLE.**

**FOR ASSISTANCE OR TO ORDER PARTS  
CONTACT OUR CUSTOMER SERVICE DEPARTMENT**

**[WWW.MONARCHSERVICE.COM](http://WWW.MONARCHSERVICE.COM)**

---

**LISTE DES PIÈCES**  
**PARTS LIST**

PIÈCE / PART #	IMAGE	DESCRIPTION	QTY / QTÉ
1		TOP SHELF ÉTAGÈRE SUPÉRIEURE	1
2		SHELF PANEL PANNEAU DE TABLETTE	1
3		SHELF PANEL PANNEAU DE TABLETTE	1
4		SHELF PANEL PANNEAU DE TABLETTE	1
5		SHELF PANEL PANNEAU DE TABLETTE	1

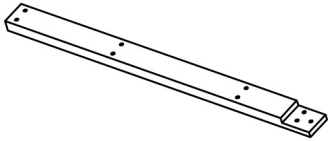
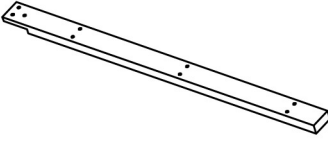
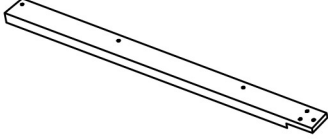
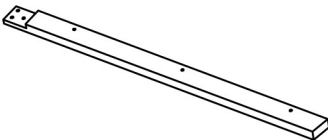

**LISTE DES PIÈCES**  
**PARTS LIST**

PIÈCE / PART #	IMAGE	DESCRIPTION	QTY / QTÉ
6		BOTTOM SHELF ÉTAGÈRE DU BAS	1
7		FRONT FACING LEFT LEG PATTE AVANT GAUCHE	1
8		FRONT FACING LEFT LEG PATTE AVANT GAUCHE	1
9		FRONT FACING RIGHT LEG PATTE AVANT DROITE	1
10		FRONT FACING RIGHT LEG PATTE AVANT DROITE	1

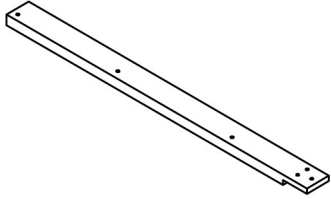
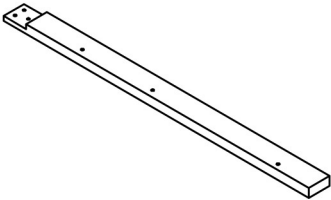
**LISTE DES PIÈCES**  
**PARTS LIST**

PIÈCE / PART #	IMAGE	DESCRIPTION	QTY / QTÉ
11		BACK LEG SUPPORT BARRE DE SOUTIEN ARRIERE (TABLE)	1
12		BACK LEG SUPPORT BARRE DE SOUTIEN ARRIERE (TABLE)	1

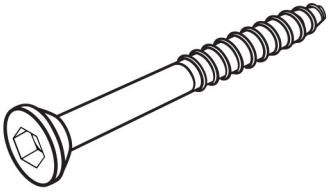

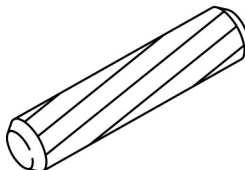
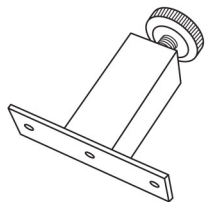
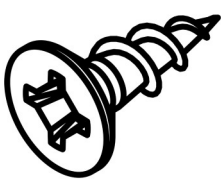
**LISTE DES PIÈCES DE MONTAGE**  
**HARDWARE LIST**

PIÈCE / PART #	IMAGE	DESCRIPTION	QTY / QTÉ
<b>A</b>		<p>ASSEMBLING SCREW - Ø1/4" X 2 5/8"</p> <p>VIS D'ASSEMBLAGE - Ø1/4" X 2 5/8"</p>	<b>12</b>
<b>B</b>		<p>ASSEMBLING SCREW - Ø1/8" X 1 1/2"</p> <p>VIS D'ASSEMBLAGE - Ø1/8" X 1 1/2"</p>	<b>6</b>
<b>C</b>		<p>WOOD DOWEL - Ø3/8" X 1"</p> <p>GOUJON DE BOIS - Ø3/8" X 1"</p>	<b>18</b>
<b>D</b>		<p>SUPPORT LEG - 3 1/8" X 1"</p> <p>PATTE DE SOUTIEN - 3 1/8" X 1"</p>	<b>1</b>
<b>E</b>		<p>ASSEMBLING SCREW - Ø1/8" X 5/8"</p> <p>VIS D'ASSEMBLAGE - Ø1/8" X 5/8"</p>	<b>2</b>

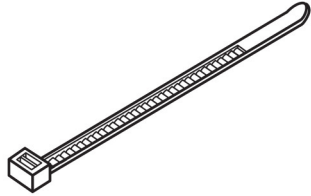
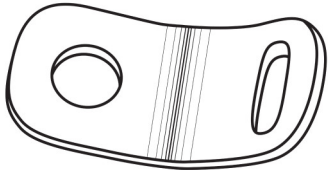
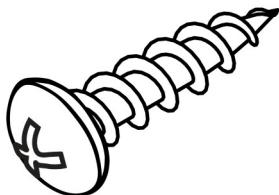
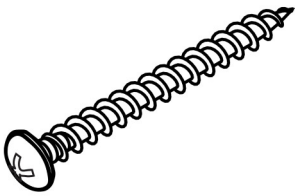
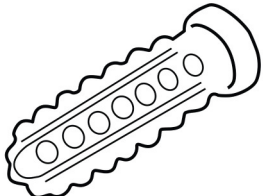
**LISTE DES PIÈCES DE MONTAGE**  
**HARDWARE LIST**

PIÈCE / PART #	IMAGE	DESCRIPTION	QTY / QTÉ
<b>F</b>		<b>ZIP TIE -</b> <b>7 3/4" X 1/8"</b> <b>ATTACHE AUTOBLOQUANTE -</b> <b>7 3/4" X 1/8"</b>	<b>1</b>
<b>G</b>		<b>METAL BRACKET -</b> <b>1/2" X 1/2"</b> <b>SUPPORT DE MÉTAL -</b> <b>1/2" X 1/2"</b>	<b>2</b>
<b>H</b>		<b>ASSEMBLING SCREW -</b> <b>Ø1/8" X 1"</b> <b>VIS D'ASSEMBLAGE -</b> <b>Ø1/8" X 1"</b>	<b>1</b>
<b>I</b>		<b>ASSEMBLING SCREW -</b> <b>Ø1/8" X 1 1/2"</b> <b>VIS D'ASSEMBLAGE -</b> <b>Ø1/8" X 1 1/2"</b>	<b>1</b>
<b>J</b>		<b>ANCHOR -</b> <b>Ø3/8" X 1 1/2"</b> <b>ANCRE -</b> <b>Ø3/8" X 1 1/2"</b>	<b>1</b>

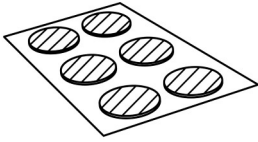
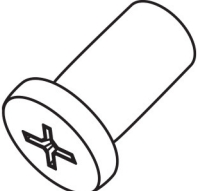
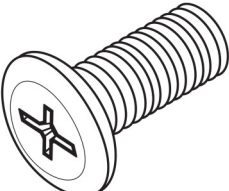
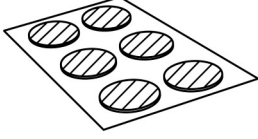
**LISTE DES PIÈCES DE MONTAGE**  
**HARDWARE LIST**

PIÈCE / PART #	IMAGE	DESCRIPTION	QTY / QTÉ
<b>K</b>		FINISHING STICKER - Ø1/2" COLLANT DE FINITION - Ø1/2"	<b>12</b>
<b>L</b>		BARREL NUT - Ø1/4" ÉCROU DE CANON - Ø1/4"	<b>9</b>
<b>M</b>		ASSEMBLING BOLT - Ø1/4" X 1/2" BOULON D'ASSEMBLAGE - Ø1/4" X 1/2"	<b>9</b>
<b>N</b>		FINISHING STICKER - Ø3/4" COLLANT DE FINITION - Ø3/4"	<b>30</b>
<b>O</b>		BARREL NUT - Ø1/4" X 1/2" ÉCROU DE CANON - Ø1/4" X 1/2"	<b>12</b>

**LISTE DES PIÈCES DE MONTAGE**  
**HARDWARE LIST**

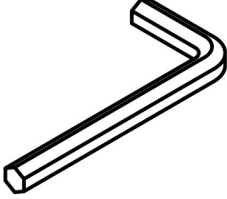
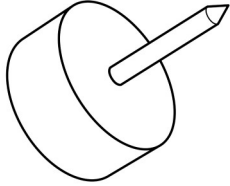
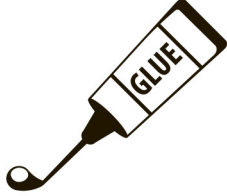
PIÈCE / PART #	IMAGE	DESCRIPTION	QTY / QTÉ
P		<p align="center">HEX KEY CLÉ HEXAGONALE</p>	1
Q		<p align="center">FLOOR PROTECTOR - Ø5/8" PROTECTEUR DE PLANCHER - Ø5/8"</p>	3
R		<p align="center">GLUE COLLE</p>	1

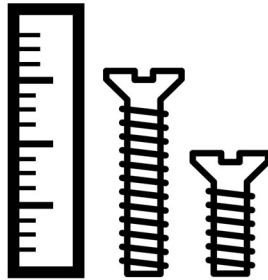

OUTIL DE VÉRIFICATION DE DIMENSIONS DES PIÈCES  
HARDWARE DIMENSIONS VERIFICATION TOOL

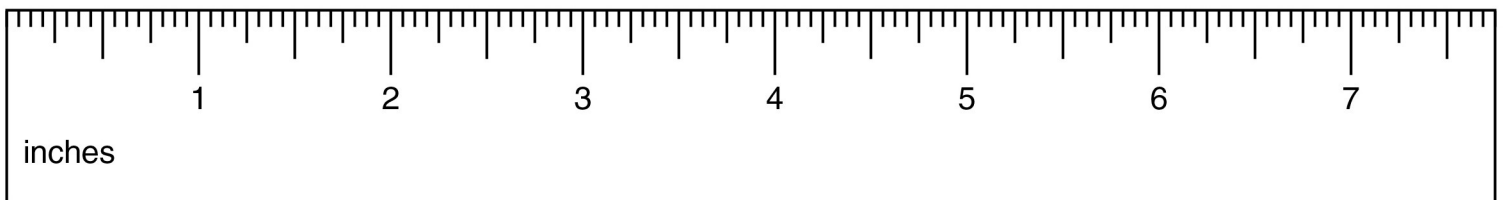

ÉTAPE / STEP 1

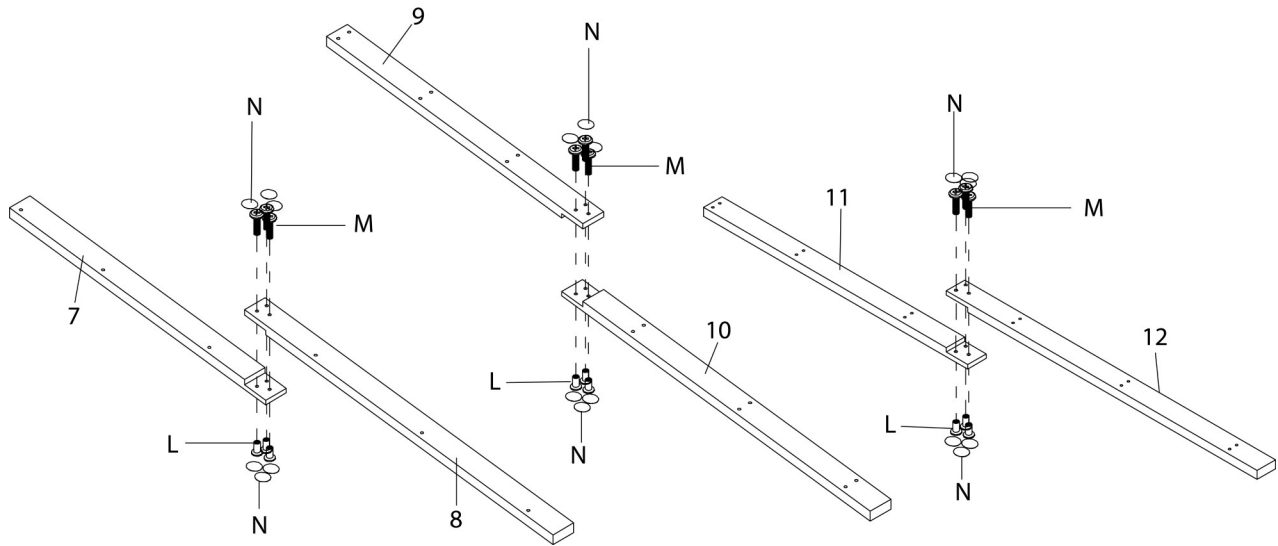

ÉTAPE / STEP 2

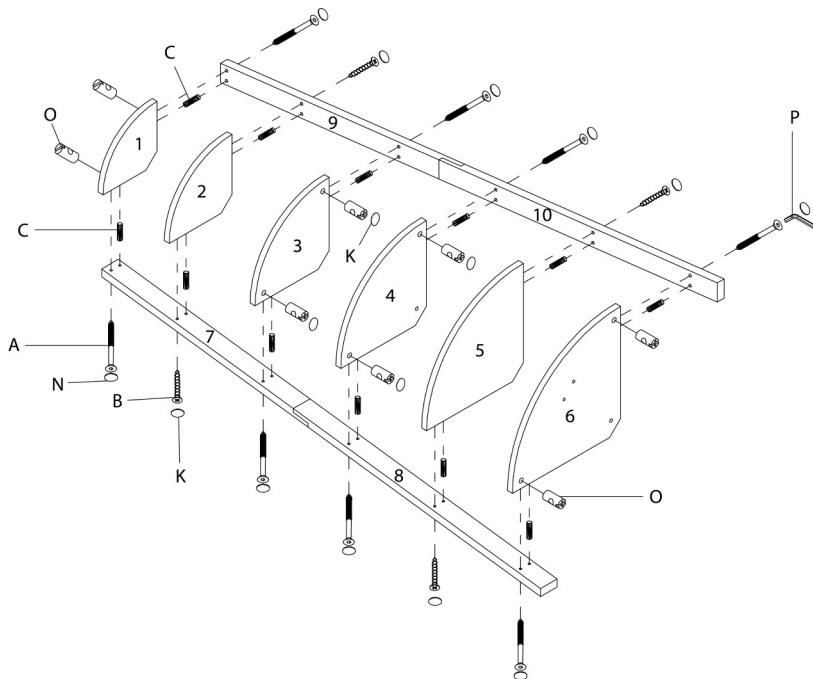

ÉTAPE / STEP 3

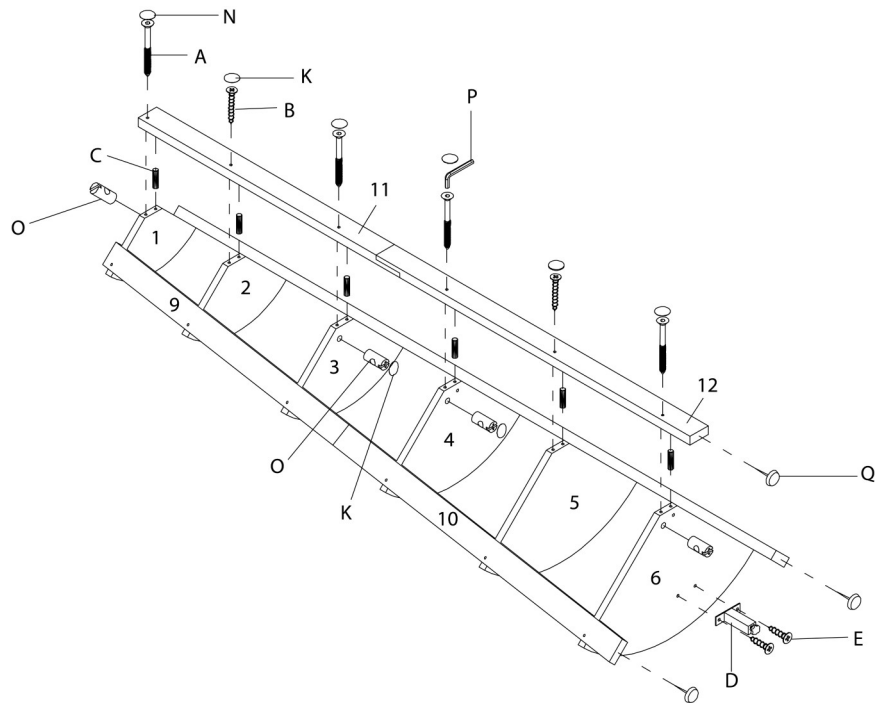

ÉTAPE / STEP 4

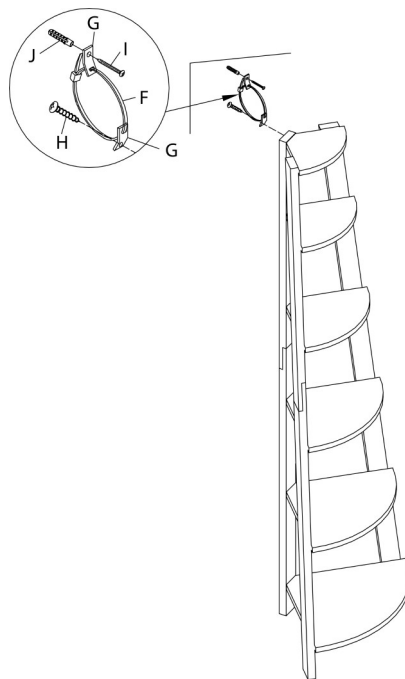

ÉTAPE / STEP 5

